

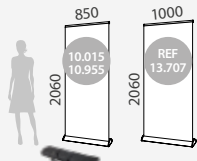

DISPLAY DETAILS





INFORMATION DIMENSIONS *mm UTILITIES

Cervera Roll Up features silver or black finish available. The aluminum design is durable, yet attractive and adds a stylish and luxurious touch. It has leveling feet and also, includes a double padded carry bag.



	QTY	N.W	G.W	C.B.M	SIZE	
Packing	4	17.4kg	20.6kg	0.083	890x190x430mm	
Uni.	1	4.35kg	5.15kg	0.018	150x135x920mm	
10.015	Graphic Size: 850x2060mm					

	QTY	N.W	G.W	C.B.M	SIZE	
Packing	4	21.6kg	23.2kg	0.097	450x200x1080mm	
Uni.	1	5.4kg	5.8kg	0.0216	150x135x1070mm	
13.707	Graphic Size: 1000x2060mm					

	QTY	N.W	G.W	C.B.M	SIZE	
Packing	4	17.6kg	21kg	0.083	890x190x430mm	
Uni.	1	4.4kg	5.25kg	0.018	150x135x920mm	
10.955	Graphic Size: 850x2060mm					

CERVERA

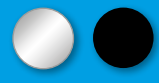

“ Ideal for providing a distinguishing and stylish touch. ”

DISPLAY DETAILS



INFORMATION

DIMENSIONS *mm

UTILITIES

Ribas luxury Roll Up features silver finish. Its unique design is durable, yet attractive. Its base has leveling feet. It is double-sided so it can be used as a sidewalk stand (ideal for areas with 2-ways traffic). Double padded carry bag.

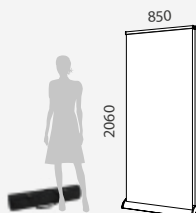

	QTY	N.W	G.W	C.B.M	SIZE
Packing	4	28kg	28.8kg	0.156	300x530x980mm
Uni.	1	7kg	7.2kg	0.03	250x135x920mm
10.013	Graphic Size: 850x2060mm				

RIBAS



DISPLAY DETAILS

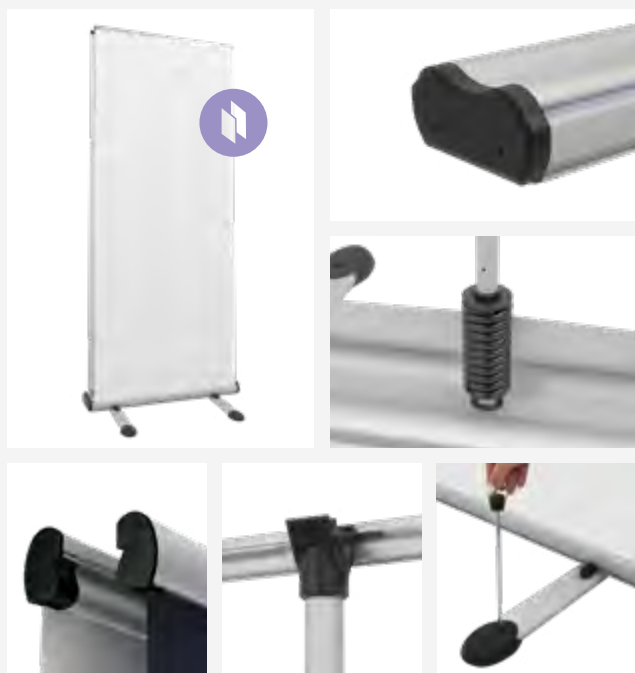

FLEX SYSTEM

*mm

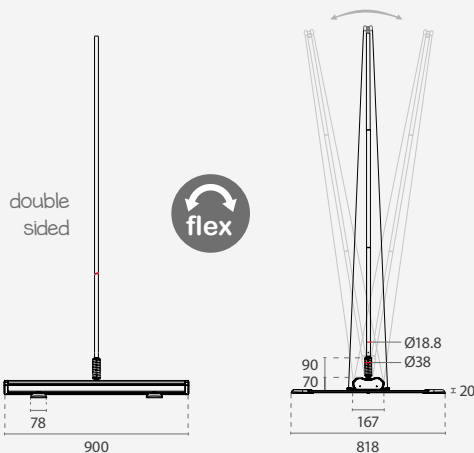

INFORMATION

DIMENSIONS *mm

UTILITIES

Ibiza RollUp features a silver aluminium finish and it is suitable for outdoor or indoor use. Its design features a flex system for resisting wind. Feet are holed for being used with 4 stakes (included). It is ideal for areas with 2-ways traffic. Double padded carry bag.

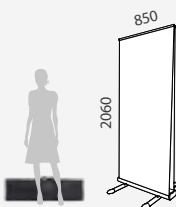

IBIZA



	QTY	N.W	G.W	C.B.M	SIZE
Packing	1	7.6kg	8.8kg	0.03	300x110x930mm
10.447	Graphic Size: 850x2060mm				

DISPLAY DETAILS

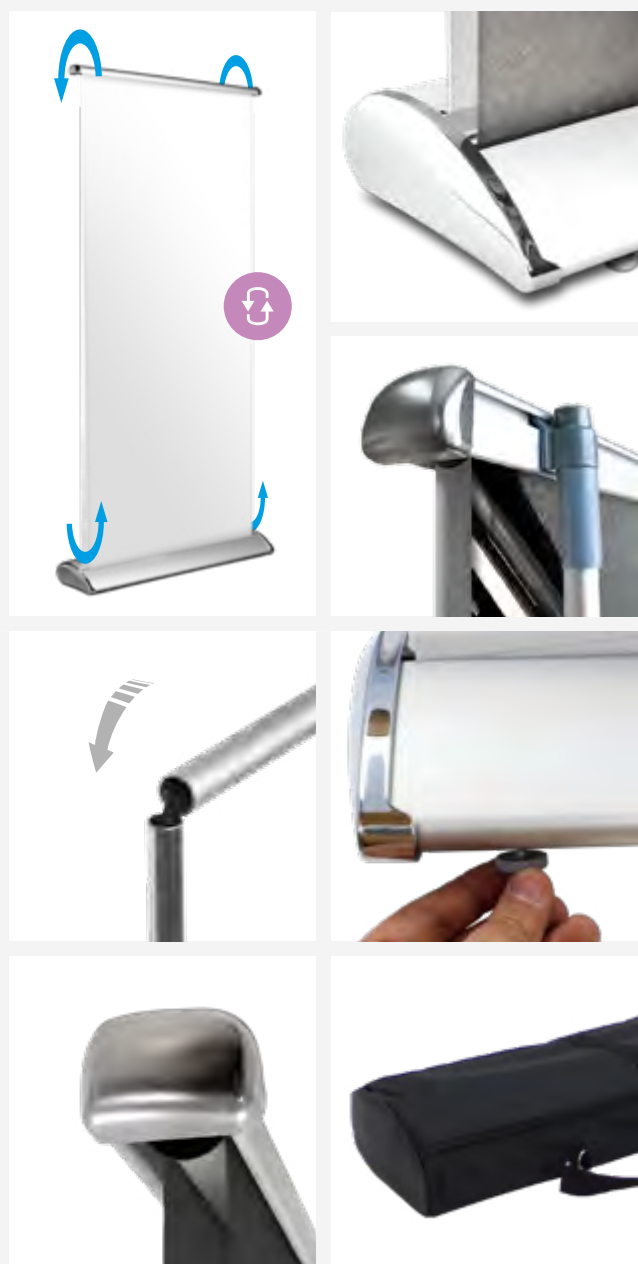

INFORMATION

DIMENSIONS *mm

UTILITIES

Pineda Roll Up features an electrical scrolling design which allows to display a large 4105mm and continuous graphic banner. Its base has leveling feet and it includes a double padded carry bag.

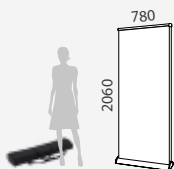

	QTY	N.W	G.W	C.B.M	SIZE
Packing	4	19.80kg	24.60kg	0.16	530x300x980mm
Uni.	1	4.95kg	6.15kg	0.034	280x130x925mm
10.022	Graphic: 780x4105mm		Visible: 780x2060mm		

PINEDA SCROLL



DISPLAY DETAILS

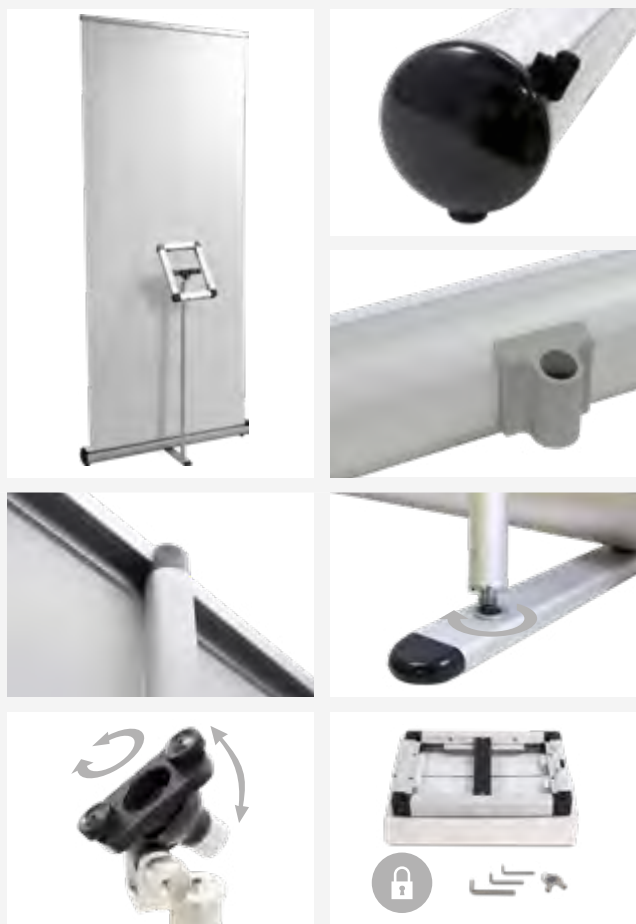

DIMENSIONS *mm

UTILITIES



INFORMATION

This Roll Up features a tablet holder (2 sizes available) whose frame allows a 360° rotation. Also, it has lock for safety use. It includes a double padded carry bag. Pineda Scroll Roll Up is ideal for conventions, tradeshows, expositions, media events or any business presentation.

	QTY	N.W	G.W	C.B.M	SIZE
Packing	1	0.75kg	0.90kg	0.003	260x47x310mm
		3.60kg	4.10kg	0.013	130x110x930mm
10.035	Roll Up Graphic Size: 850x2060mm Size for Tablets: ±185.8x241.3mm				

	QTY	N.W	G.W	C.B.M	SIZE
Packing	1	0.75kg	0.90kg	0.003	260x47x310mm
		3.60kg	4.10kg	0.013	130x110x930mm
10.053	Roll Up Graphic Size: 850x2060mm Size for Tablets: ±195.5x240mm				

TABLET HOLDER ROLL UP

“ See more Tablet Holders in InFo & Frames (Chapter 6) ”



* tablet is not included